

1 2 3 4 5 6 7 8 9 10 11 12 13 14

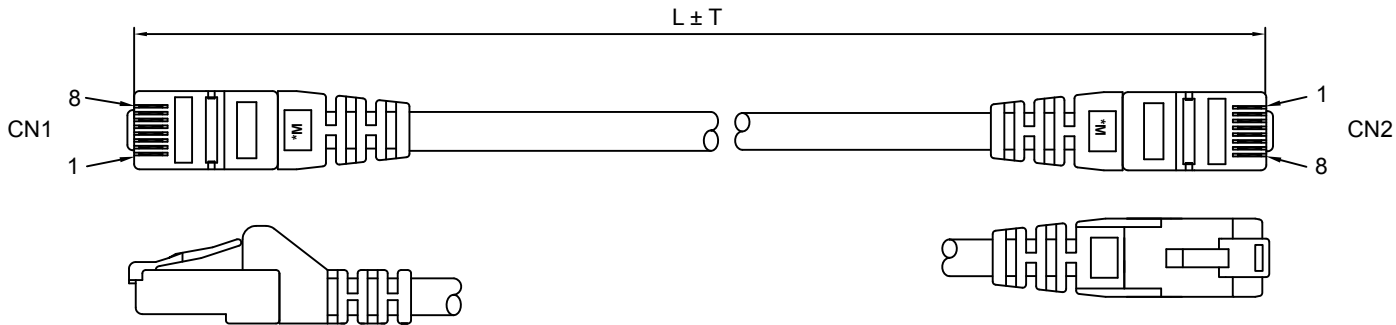

**PIN OUT**

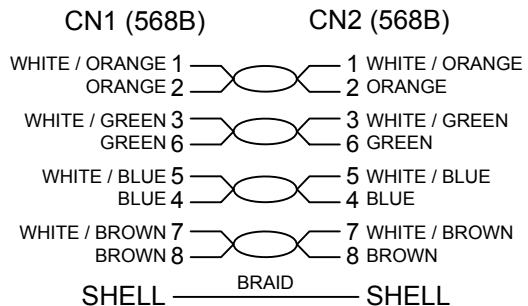

Spezifikation / Specification	CAT 6
Kabeltyp / Cable type	Rundkabel / round cable
Innenleiter, Material / Inner conductor material	CU (Kupfer) / CU (copper)
Innenleiter, Aderdurchmesser / Inner conductor, core diameter	(7/0.12 ± 0.005 mm)
AWG	28/7 (stranded)
Schirmungsklasse / Shielding class	S/FTP (PiMF)
Anzahl Schirmungen / Number of shieldings	2 x
Typ 1, Schirmung / Type 1, shielding	Folie (Alu) PiMF / foil (alu) PiMF
Typ 2, Schirmung / Type 2, shielding	Geflecht (Alu) Gesamtschirm / braid (alu) overall shield
Durchmesser Kabelmantel (ca.) / Cable sheath diameter (approx.)	Ø 6.0 ± 0.2 mm, LSZH *
Knickschutz / Kink protection	beidseitig / both sides
LSZH-konform / LSZH compliant	ja / yes
Anschluss, Typ / Connection, type	RJ45-Stecker (8P8C) / RJ45 male (8P8C)
Anschluss, Schirmung / Connection, shielding	ja / yes
Anschluss 2, Typ / Connection 2, type	RJ45-Stecker (8P8C) / RJ45 male (8P8C)
Rastnasenschutz / Latch protection	beidseitig / both sides
max. Bandbreite / max. bandwidth	250 MHz

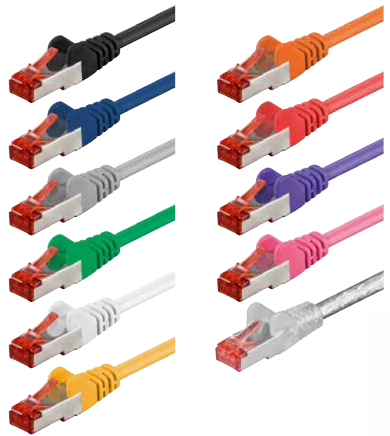

**CAT 6 Patchkabel, S/FTP (PiMF)**

- doppelt geschirmtes LAN/Netzwerkkabel zum Anschluss Ihrer Netzwerkkomponenten mit 2x RJ45 Steckern
- CAT 6 getestet
- mit vergoldeten Kontaktflächen (PINs)
- Aderpaarschirmung: PiMF (Paare in Metall Folie) + Gesamtschirmung: Geflecht
- Längenangabe auf Slimline-Knickschutztülle
- mit Rastnasenschutz
- Paarfolge nach EIA/TIA 568B
- Betriebstemperatur: -20 °C bis 65 °C

**CAT 6 patch cable S/FTP (PiMF)**

- double shielded LAN/network cable to connect network components with 2 x RJ45 connectors
- CAT 6 tested
- with gold plated PINs
- pairs screening: PiMF (pairs in metal foil) + outer shield: braiding
- with length indication on the slimline strain relief
- with latch protection
- suitable for Power over Ethernet (PoE/PoE+)
- Operating temperature: -20 °C up to 65 °C



**Änderungen**

		Datum	Name	Bezeichnung	Blatt
Datum	Name	gez.:	27.08.2020	sm	1 / 2
		gepr.:	27.08.2020	ac	
		Norm:		Zeichnungs-Nr.:	von
Änderungen vorbehalten / Subject to change				92452ff	

1 2 3 4 5 6 7 8 9 10 11 12 13 14

1 2 3 4 5 6 7 8 9 10 11 12 13 14

A

Farbe / Colour	Art.	L [m]	
	schwarz / black	92459	0.15
	93215	0.25	
	68687	0.50	
	68693	1.00	
	95584	1.50	
	68696	2.00	
	68698	3.00	
	68700	5.00	
	68702	7.50	
	68694	10.00	
	68695	15.00	
	68697	20.00	
	95651	25.00	
	68699	30.00	
68701	50.00		

Farbe / Colour	Art.	L [m]	
	grau / grey	92455	0.15
	93212	0.25	
	50885	0.50	
	50886	1.00	
	95579	1.50	
	50887	2.00	
	50888	3.00	
	50889	5.00	
	50890	7.50	
	50891	10.00	
	50892	15.00	
	50893	20.00	
	95646	25.00	
	50894	30.00	
50895	50.00		

Farbe / Colour	Art.	L [m]	
	weiß / white	92462	0.15
	93217	0.25	
	93501	0.50	
	93502	1.00	
	95587	1.50	
	93505	2.00	
	93507	3.00	
	93509	5.00	
	93511	7.50	
	93503	10.00	
	93504	15.00	
	93506	20.00	
	95656	25.00	
	93508	30.00	
93510	50.00		

Farbe / Colour	Art.	L [m]	
	orange / orange	92457	0.15
	93340	0.25	
	93467	0.50	
	93468	1.00	
	95582	1.50	
	93471	2.00	
	93473	3.00	
	93475	5.00	
	93477	7.50	
	93469	10.00	
	93470	15.00	
	93472	20.00	
	95649	25.00	
	93474	30.00	
93476	50.00		

Farbe / Colour	Art.	L [m]	
	violett / violett	92461	0.15
	93342	0.25	
	93535	0.50	
	93536	1.00	
	95586	1.50	
	93539	2.00	
	93541	3.00	
	93543	5.00	
	93545	7.50	
	93537	10.00	
	93538	15.00	
	93540	20.00	
	95653	25.00	
	93542	30.00	
93544	50.00		

Farbe / Colour	Art.	L [m]	
	transparent / transparent *	92460	0.15
	93341	0.25	
	93546	0.50	
	93547	1.00	
	93550	2.00	
	93552	3.00	
	93567	5.00	
	93548	10.00	
	93554	50.00	

\* transparentes Kabelmaterial =PVC / transparent outer sheet material = PVC

B

C

D

E

F

G

H

Farbe / Colour	Art.	L [m]	
	blau / blue	92452	0.15
	93211	0.25	
	68266	0.50	
	68267	1.00	
	95576	1.50	
	68268	2.00	
	68269	3.00	
	68270	5.00	
	68271	7.50	
	68272	10.00	
	68273	15.00	
	68274	20.00	
	95643	25.00	
	68275	30.00	
68276	50.00		

Farbe / Colour	Art.	L [m]	
	grün / green	92454	0.15
	93213	0.25	
	68288	0.50	
	68289	1.00	
	95580	1.50	
	68290	2.00	
	68291	3.00	
	68292	5.00	
	68293	7.50	
	68294	10.00	
	68295	15.00	
	68296	20.00	
	95647	25.00	
	68297	30.00	
68298	50.00		

Farbe / Colour	Art.	L [m]	
	gelb / yellow	92453	0.15
	93210	0.25	
	68299	0.50	
	68300	1.00	
	95578	1.50	
	68301	2.00	
	68302	3.00	
	68303	5.00	
	68304	7.50	
	68305	10.00	
	68306	15.00	
	68307	20.00	
	95645	25.00	
	68308	30.00	
68309	50.00		

Farbe / Colour	Art.	L [m]	
	rot / red	92458	0.15
	93214	0.25	
	68277	0.50	
	68278	1.00	
	95583	1.50	
	68279	2.00	
	68280	3.00	
	68281	5.00	
	68282	7.50	
	68283	10.00	
	68284	15.00	
	68285	20.00	
	95650	25.00	
	68286	30.00	
68287	50.00		

Farbe / Colour	Art.	L [m]	
	magenta / magenta	92456	0.15
	93339	0.25	
	93433	0.50	
	93434	1.00	
	95581	1.50	
	93437	2.00	
	93439	3.00	
	93441	5.00	
	93443	7.50	
	93435	10.00	
	93436	15.00	
	93438	20.00	
	93440	30.00	
	93442	50.00	

I

J

Änderungen

Datum	Name	gez.:	Datum	Name
		gez.:	27.08.2020	sm
		gepr.:	27.08.2020	ac
		Norm:		
Änderungen vorbehalten / Subject to change				

Bezeichnung	Blatt
CAT 6-xxxx S/FTP PIMF CU LSZH* 	2 / 2
x.xx m	
Zeichnungs-Nr.:	von
92452ff	

1 2 3 4 5 6 7 8 9 10 11 12 13 14